

Carbon dioxide

CO₂ METER

Model : GC-2028



Your purchase of this CO₂ METER MONITOR marks a step forward for you into the field of precision measurement. Although this CO₂ METER is a complex and delicate instrument, its durable structure will allow many years of use if proper operating techniques are developed. Please read the following instructions carefully and always keep this manual within easy reach.

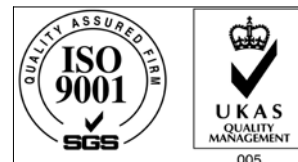

OPERATION MANUAL

TABLE OF CONTENTS

1. FEATURES.....	1
2. SPECIFICATIONS.....	1
3. FRONT PANEL DESCRIPTION.....	4
3-1 Display.....	4
3-2 Power Button.....	4
3-3 Hold Button (Esc Button).....	4
3-4 REC Button (Enter Button).....	4
3-5 Set Button (▲ Button).....	4
3-6 Alarm (▼ Button).....	4
3-7 Battery Compartment/Cover.....	4
3-8 Stand.....	4
3-9 Input socket.....	4
3-10 RS-232 Output Terminal.....	4
3-11 DC 9V Power Adapter Input Socket.....	4
3-12 Reset button.....	4
3-13 CO2 Probe Head.....	4
3-14 CO2 Probe Handle.....	4
3-15 CO2 Probe Plug.....	4
4. MEASURING PROCEDURE.....	6
4-1 CO2 measurement.....	6
4-2 CO2 alarm setting.....	6
4-3 Data Hold.....	7
4-4 Data Record (Max, Min reading).....	7
5. ADVANCED SETTING.....	8
5-1 Auto power off enable/disable.....	8
5-2 Change the Temp °C, °F unit.....	9
5-3 CO2 alarm value setting.....	9
5-4 CO2 altitude compensation value setting.....	10
6. RS232 PC SERIAL INTERFACE.....	10
7. BATTERY REPLACEMENT.....	12
8. SYSTEM RESET.....	12
9. ANNEX.....	13

1. FEATURES

- * NDIR method principal for CO₂ (Carbon dioxide) measurement, available for long term operation.
- * High repeatability and high accuracy.
- * Separate probe, easy operation and convenient for remote measurement.
- * CO₂ function with alarm setting.
- * Can set the altitude compensation value with default.
- * Large S-TN LCD, high contrast, easy readout.
- * Data hold function for freezing the desired value on display.
- * Records Maximum and Minimum readings with Recall.
- * RS232/USB computer interface.
- * Microprocessor circuit assures maximum possible accuracy, provides special functions and features.
- * Heavy duty & compact housing with hard carrying case, designed for easy carry out & operation.
- * Auto shut off is available to save battery life.
- * Power supply from batteries or DC 9V adapter in.

2. SPECIFICATIONS

2-1 General Specifications

Circuit	Custom one-chip of microprocessor LSI circuit.
Display	LCD size : 52 mm x 38 mm dual function LCD display.
Measurement	CO ₂ (Carbon dioxide), Temp.

Unit	CO2	ppm
	Temp.	°C, °F
Response Time	CO2 : < 2 min. typically. * <i>Reach the 63% reading value</i> * <i>Depend the environment air circulation.</i>	
CO2 altitude compensation setting	0 to 9,000 meters.	
Temperature Compensation	Automatic temp. compensation.	
Advanced setting	Auto power off enable/disable setting	
	°C/°F setting	
	CO2 alarm value setting	
	CO2 altitude value setting	
Alarm Function	Setting for CO2 measurement value.	
Data Hold	Freeze the display reading.	
Memory Recall	Maximum & Minimum value.	
Display Sampling Time	Approx. 1 second.	
Power off	Auto shut off saves battery life or manual off by push button.	
Data Output	RS 232/USB PC serial interface. * <i>Connect the optional RS232 cable</i> <i>UPCB-02 will get the RS232 plug.</i> * <i>Connect the optional USB cable</i> <i>USB-01 will get the USB plug.</i>	

Operating Temperature	0 to 50 °C.
Operating Humidity	Less than 85% R.H.
Power Supply	DC 1.5 V battery (UM3, AA) x 6 PCs, or equivalent.
Power Current	CO2 measurement <i>Approx. DC 9.6 mA for 90% period.</i> <i>Approx. DC 128 mA for 10% period.</i>
Weight	Main instrument : 372 g/0.82 LB. <i>@ Battery is included.</i>
	CO2 probe : 158 g/0.35 LB.
Dimension	Main instrument : 173 x 68 x 42 mm (7.9 x 2.7x 1.2 inch)
	CO2 Probe : 185 x 38 x 26 mm
Accessories Included	Instruction manual.....1 PC CO2 probe.....1 PC Hard Carrying case..... 1 PC
Optional Accessories	RS232 cable, UPCB-02 USB cable, USB-01 Data Acquisition software, SW-U801-WIN

2-2 Electrical Specifications (23 ± 5 °C)

CO2 (Carbon dioxide) 23 ± 5 °C .	Range	0 to 4,000 ppm
	Resolution	1 ppm
	Accuracy	± 40 ppm <i>* ≤ 1,000 ppm.</i>
		± 5% of reading <i>* > 1,000 ppm ≤ 3,000 ppm.</i>
		± 250 ppm typically <i>* > 3,000 ppm, reference only</i>
Repeatability	± 20 ppm <i>* ≤ 3,000 ppm.</i>	
Temperature	Range	0 °C to 50 °C , 32 °F to 122 °F .
	Resolution	0.1 degree
	Accuracy	°C - 0.8 °C , °F - 1.5 °F .

@ Above specification tests under the environment RF Field Strength less than 3 V/M & frequency less than 30 MHz only.

3. FRONT PANEL DESCRIPTION

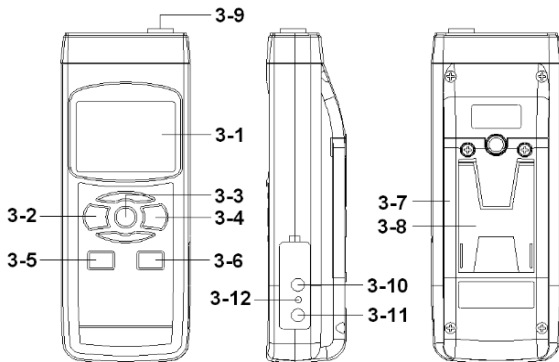

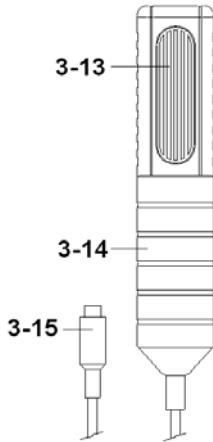



- 3-1 Display
- 3-2 Power Button
- 3-3 Hold Button (Esc Button)
- 3-4 REC Button (Enter Button)
- 3-5 Set Button (▲ Button)
- 3-6 Alarm (▼ Button)
- 3-7 Battery Compartment/Cover
- 3-8 Stand
- 3-9 Input socket
- 3-10 RS-232 Output Terminal
- 3-11 DC 9V Power Adapter Input Socket
- 3-12 Reset button
- 3-13 CO2 Probe Head
- 3-14 CO2 Probe Handle
- 3-15 CO2 Probe Plug

4. MEASURING PROCEDURE

4-1 CO₂ measurement

- 1) Plug the " CO₂ Probe Plug " (3-15, Fig. 1) into the " Probe Input Socket " (3-9, Fig. 1).
- 2) Power on the meter by pressing the " Power Button " (3-2, Fig. 1),
 - * The LCD will show the text " WARM UP "
 - * The " Sampling indicator  " will be rotated in cycling.Warm up time will take about 45 seconds, then display will show the CO₂ (PPM) value in the upper LCD, the lower LCD will show the temperature value.
 - * When the " Sampling indicator  " rotate one cycle, the CO₂ measuring value will update one time.
 - * Response Time of CO₂ is < 2 min. typically, however it is depend on the environment air circulation.
- 3) The meter Temp. display unit is defaulted to " °C ". If intend to let the meter's temperature unit default to " °F " , then please refer section 5-2 (page 9).

4-2 CO₂ alarm setting

- During the CO₂ measurement, if press the " Alarm Button " (3-6, Fig. 1) once, the display will show the indicator " ALARM " and going on to execute the CO₂ alarm function. If the measurement value over the " Alarm setting value " , the buzzer will sound.
- * If press the " Alarm Button " (3-6, Fig. 1) once again, the CO₂ alarm function will be disabled, the " ALARM " indicator on the LCD will be disappeared.
 - * The procedures of setting the CO₂ alarm value, please refer section 5-3 (page 9).

4-3 Data Hold

During the measurement, press the " Hold Button " (3-3, Fig. 1) once will hold the measured value & the LCD will display a " HOLD " symbol.

- * Press the " Hold Button " once again will release the data hold function.

4-4 Data Record (Max., Min. reading)

- * The data record function records the maximum and minimum readings. Press the " REC Button " (3-4, Fig. 1) once to start the Data Record function and there will be a " REC. " symbol on the display.

- * With the " REC. " symbol on the display :

- a) Press the " REC Button " (3-4, Fig. 1) once, the " REC. MAX. " symbol along with the maximum value will appear on the display.

If intend to delete the maximum value, just press the " Hold Button " (3-3, Fig. 1) once, then the display will show the " REC. " symbol only & execute the memory function continuously.

- b) Press the " REC Button " (3-4, Fig. 1) again, the " REC. MIN. " symbol along with the minimum value will appear on the display.

If intend to delete the minimum value, just press the " Hold Button " (3-3, Fig. 1) once, then the display will show the " REC. " symbol only & execute the memory function continuously.

- c) To exit the memory record function, just press the " REC " button for 2 seconds at least. The display will revert to the current reading.

5. ADVANCED SETTING

When execute the following Advanced Setting Procedures should cancel the " Hold function " and the " Record function " first. The display will not show the " HOLD " and the " REC " indicator

Press the " Set Button " (3-5, Fig. 1) continuously at least two seconds will enter the " Advanced Setting ", then press the " Set Button " (3-5, Fig. 1) once a while in sequence to select the four main function, the lower display will show :

PoFF.....Auto power ON/OFF management

t-CF..... Change the Temp °C, °F unit

AL.....Setting the CO2 alarm value

Alt.....Setting the CO2 altitude compensation value

5-1 Auto power ON/OFF

When the lower display show " PoFF " :

1) Press the " Enter Button " (3-4, Fig. 1) once, the upper display will show " 0 ", use the " ▲ Button " (3-5, Fig. 1) or " ▼ Button " (3-6, Fig. 1) to select the upper value to " 0 " or " 1 ".

0 - Auto Power Off management will disable.

1 - Auto Power Off management will enable..

2) After select the upper value to " 0 " or " 1 ", press the " Enter Button " (3-4, Fig. 1) will save the setting value (function) with default.

* If before press the " Enter Button ", just press the " ESC Button " (3-3, Fig. 1) will escape the Advanced Setting procedures without saving the value (function) into the circuit memory.

5-2 Change the Temp °C, °F unit

When the lower display show " t-CF " :

- 1) Press the " Enter Button " (3-4, Fig. 1) once, the upper display will show " 0 ", use the " ▲ Button " (3-5, Fig. 1) or " ▼ Button " (3-6, Fig. 1) to select the upper value to " 0 " or " 1 ".

0 - The Temp. unit is °C.

1 - The Temp. unit is °F.

- 2) After select the upper value to " 0 " or " 1 ", press the " Enter Button " (3-4, Fig. 1) will save the setting Temp. unit (°C, °F) with default.

* If before press the " Enter Button ", just press the " ESC Button " (3-3, Fig. 1) will escape the Advanced Setting procedures without saving the value (function) into the circuit memory.

5-3 Setting the CO2 alarm value

When the lower display show " AL " :

- 1) Press the " Enter Button " (3-4, Fig. 1) once, the upper display will show " CO2 alarm value " with PPM unit, use the " ▲ Button " (3-5, Fig. 1) or " ▼ Button " (3-6, Fig. 1) to select the " CO2 alarm value ".

- 2) After setting the CO2 alarm value, press the " Enter Button " (3-4, Fig. 1) will save the setting value with default.

* If before press the " Enter Button ", just press the " ESC Button " (3-3, Fig. 1) will escape the Advanced Setting procedures without saving the alarm value into the circuit memory.

5-4 Setting the CO2 altitude compensation value

When the lower display show " Alt " :

- 1) Press the " Enter Button " (3-4, Fig. 1) once, the upper display will show " CO2 altitude compensation value " with meter unit, use the " ▲ Button " (3-5, Fig. 1) or " ▼ Button " (3-6, Fig. 1) to select the " CO2 altitude compensation value " .
- 2) After setting the CO2 altitude compensation value, press the " Enter Button " (3-4, Fig. 1) will save the setting value with default.

* If before press the " Enter Button ", just press the " ESC Button " (3-3, Fig. 1) will escape the Advanced Setting procedures without saving the alarm value into the circuit memory.

6. RS232 PC SERIAL INTERFACE

The instrument has RS232 PC serial interface via a 3.5 mm terminal (3-10, Fig. 1).

The data output is a 16 digit stream which can be utilized for user's specific application.

A RS232 lead with the following connection will be required to link the instrument with the PC serial port.

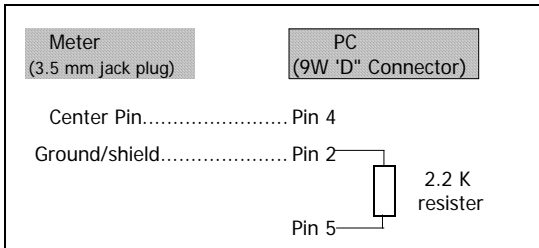

The 16 digits data stream will be displayed in the following format :

D15 D14 D13 D12 D11 D10 D9 D8 D7 D6 D5 D4 D3 D2 D1 D0

Each digit indicates the following status :

D15	Start Word = 02		
D14	4		
D13	When send the upper display data = 1 When send the lower display data = 2		
D12 & D11	Annunciator for Display		
	°C = 01	PPM = 19	
	°F = 02		
D10	Polarity 0 = Positive 1 = Negative		
D9	Decimal Point(DP), position from right to the left 0 = No DP, 1= 1 DP, 2 = 2 DP, 3 = 3 DP		
D8 to D1	Display reading, D8 = MSD, D1 = LSD For example : If the display reading is 1234, then D8 to D1 is : 00001234		
D0	End Word = 0D		

RS232 setting

Baud rate	9600
Parity	No parity
Data bit no.	8 Data bits
Stop bit	1 Stop bit

7. BATTERY REPLACEMENT

- 1) When the left corner of LCD display show " , it is necessary to replace the battery. However, in-spec. measurement may still be made for several hours after low battery indicator appears before the instrument become inaccurate.
- 2) Loose the screws of the " Battery Cover " (3-7, Fig. 1) and take away the " Battery Cover " from the instrument and remove the battery.
- 3) Replace with DC 1.5 V battery (UM3, AA, Alkaline/heavy duty) x 6 PCs, and reinstate the cover.
- 4) Make sure the battery cover is secured after changing the battery.

8. SYSTEM RESET

If the meter happen the troubles such as :

CPU system is hold (for example, the key button can not be operated...).

Then make the system RESET will fix the problem.
The system RESET procedures will be either following method :

During the power on, use a pin to press the " Reset Button " (3-12, Fig. 1) once a while will rest the circuit system, After execute the " System reset " the setting value of : Advanced Setting " will be cleared and return to default value.

9. ANNEX

The follow CO2 value are for the requirement for different environment, however it is for reference only.

Building, office, home	≤ 1,000 PPM
School	≤ 1,500 PPM
Hotel, public area	≤ 1,500 PPM
Indoor swimming pool	≤ 1,500 PPM
ASHRAE	≤ 1,000 PPM
WHO	≤ 920 PPM