

2 in 1

Air velocity/Temp., Air flow

ANEMOMETER

Model : SP-82AM (Sper version)



Your purchase of this ANEMOMETER marks a step forward for you into the field of precision measurement. Although this METER is a complex and delicate instrument, its durable structure will allow many years of use if proper operating techniques are developed. Please read the following instructions carefully and always keep this manual within easy reach.

TABLE OF CONTENTS

1. FEATURES.....	1
2. SPECIFICATIONS.....	1
3. FRONT PANEL DESCRIPTION.....	3
3-1 Hold button.....	3
3-2  button (Power button).....	3
3-3 REC button.....	3
3-4 LCD display.....	3
3-5 Wristlet.....	3
3-6 Anemometer Vane.....	3
3-7 Battery Compartment / Cover.....	3
3-8 Buttons operation label.....	3
4. MEASURING PROCEDURES.....	4
4-1 Power on/off.....	4
4-2 LCD backlight on/off.....	4
4-3 Function selection.....	4
4-4 Unit selection.....	5
4-5 Air flow measurement.....	5
4-6 Hold Function.....	6
4-7 REC (Record) function	6
4-8 Auto power off disable.....	7
5. BATTERY REPLACEMENT.....	7

1. FEATURES

- * 2 in 1 professional environment instruments:
1. Air velocity, 2. Air flow (CMM, CFM).
- * Tiny bone shape with lightweight and small size case design are suitable for handling with one hand.
- * Wristlet design provides extra protection to the instrument especially for user one hand operation.
- * Low-friction ball bearing mounted wheel design provides high accuracy at high and low air velocity.
- * Built- in microprocessor circuit assures excellent performance and accuracy.
- * Concise and compact buttons arrangement, easy operation.
- * Memorize the maximum and minimum value with recall.
- * Hold function to freeze the current reading value.

2. SPECIFICATIONS

2-1 General Specifications

Display	8 mm LCD display
Measurement	1. Air velocity 2. Air flow (CMM, CFM).
Operating Humidity	Max. 80% RH.
Operating Temperature	0 to 50 °C (32 to 122 °F)
Over Input Display	Indication of "- - - - "
Power Supply	CR 2032 DC 3V battery
Power Consumption	Approx. DC 5 mA

Weight	160g (battery included)
Dimension	HWD 120 x 45 x 20 mm (4.7 x 1.8 x 1.2 inch).
Standard Accessory	Instruction Manual

2-2 Electrical Specification (23 ± 5°C)

Air velocity

<i>Unit</i>	<i>Range</i>	<i>Resolution</i>	<i>Accuracy</i>
ft/min	80 to 3937 ft/min	1 ft/min	$\leq 20 \text{ m/s} : \pm 3\% \text{ F.S.}$ $> 20 \text{ m/s} : \pm 4\% \text{ F.S.}$
m/s	0.4 to 20.0 m/s	0.1 m/s	
km/h	1.4 to 72.0 km/h	0.1 km/h	
MPH	0.9 to 44.7 mile/h	0.1 MPH	
knots	0.8 to 38.8 knots	0.1 knots	

Remark :

ft/min : feet per minute

MPH : miles per hour

m/s : meters per second

knots : nautical miles per hour

km/h : kilometers per hour

Ar flow

<i>Unit</i>	<i>Range</i>	<i>Resolution</i>
CMM	0.024 to 36000	0.001/0.01/0.1/1
CFM	0.847 to 1271300	0.001/0.01/0.1/1/10 (x10)/100 (x100)

3. FRONT PANEL DESCRIPTION

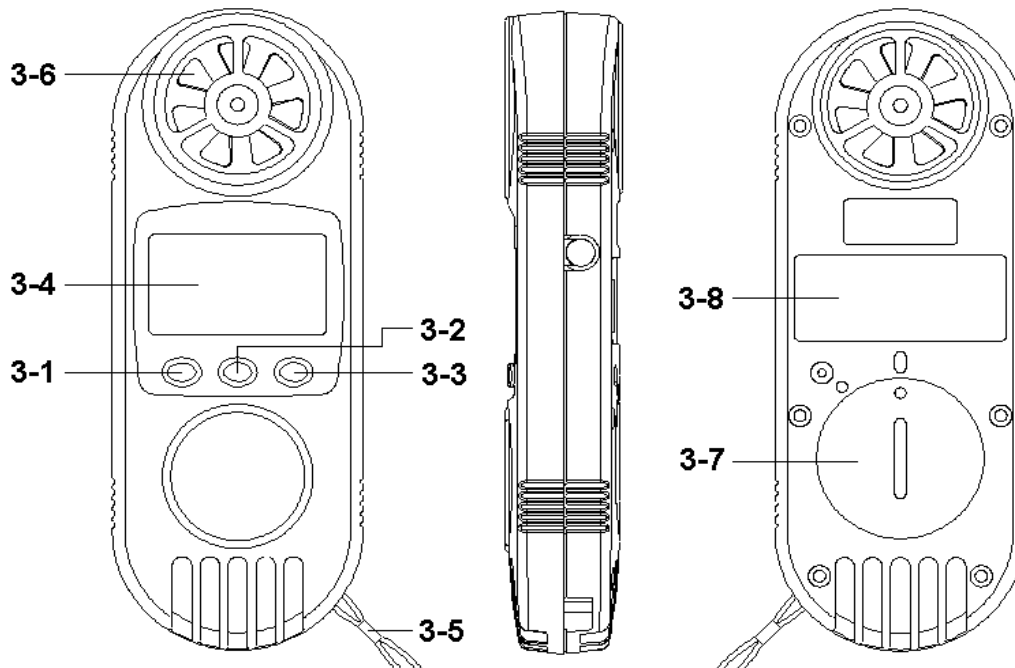



Fig. 1

- 3-1 Hold button
- 3-2  Button (Power button)
- 3-3 REC button
- 3-4 LCD display
- 3-5 Wristlet
- 3-6 Anemometer Vane
- 3-7 Battery Compartment / Cover
- 3-8 Buttons operation label

4. MEASURING PROCEDURE

4-1 Power on/off

 Button = Power Button

1) *Power on* :

Press " Power Button " once.

2) *Power off* :

During power on, press " Power Button " > 3 seconds.
will power off.

4-2 LCD backlight on/off

During power on, press " Power Button " once, then the LCD backlight will be on 5 seconds then off automatically,

4-3 Function selection

The meter can select 2 kind function as :

- a. Anemometer
- b. Air flow (CMM, CFM)

During power on, press the " Hold button " continuously (not release the button), the Display will show the following text in sequence :

<i>Display text</i>	<i>Function</i>
An	Anemometer (Air velocity)
AirFL	Air flow (CMM, CFM)

Until the Display show the desired function, just release the " Hold button " , the meter will execute this function with default.

4-4 Unit selection

During power on, press the " REC button " continuously > 3 seconds, the Display will show the text " Unit " release the " REC button ", then press "  button " to select the desired unit, after the desired unit is selected, press the " REC button " to save the unit with default.

REC button = Enter button

The selection unit for all function are :

<i>Measurement</i>	Unit
Air velocity	M/S, Km/h, mph, knot, FPM
Air flow	CMM, CFM

side, it is normal.

4-5 Air flow measurement

1) Power on, select the function to " Air flow measurement " (refer to chapter 4-3), now the meter is ready for Air flow measurement.

2) Set the measurement area dimension :

Press the " Hold button " once, the Display will show the indicator " HOLD " then press the " REC button " continuously until the left down bottom of Display show " m-2 " or " F-2 "

m-2 = meter square

F-2 = ft square

- 3) Use the " Hold button " and the "  button " to adjust the air flow dimension value.
Until the desired dimension value is set, press " REC button " to save the setting value with default.

 button = ▲ button

Hold button = ▼ button

REC button = Enter button

4-6 Hold Function

Whenever press the " Hold Button " will freeze the current reading value with a "HOLD" symbol on the display.
To release the Hold function, just press the " Hold button " once again, the " HOLD " indicator will be disappeared.

4-7 REC (Record) function

- 1) The REC (Record) function can record and display the maximum and minimum reading values. Start the Record function by pressing the " REC Button " once. There will be a " REC " symbol on the display.
- 2) With the REC symbol on the display :
 - (a) Press the " REC button " once and the " Max " symbol along with the maximum value will appear on the display.
 - (b) Press the " REC button " again, the " MIN " symbol along with the minimum value will appear on the display.
 - (c) To exit the memory record function, press the " REC button " continuously for at least 2 seconds. The display will revert to the current reading.
 - (d) Clear the recorded MAX or MIN value by pressing the " Hold button " once. Previous recorded MAX/MIN value will be given up and then revert to the REC. function keep on recording.

4-8 Auto power off disable

In order to prolong the battery life, the instrument has "Auto Power Off " function. The meter will switch off automatically if no buttons are pressed for around 10 minutes.

However if intend disable the " Auto power off " function, just execute the " REC " function (above chapter 4-7), then the Auto power off function will be canceled.

5. BATTERY REPLACEMENT

- 1) When the LCD display shows "  " symbol, it is necessary to replace the battery. However measurement may still be made for several hours after the low battery indicator appears.
- 2) Open the " Battery Compartment / Cover " (3-7, Fig. 1) and remove the battery.
- 3) Install the battery (CR2032) and then reinstate the cover.